

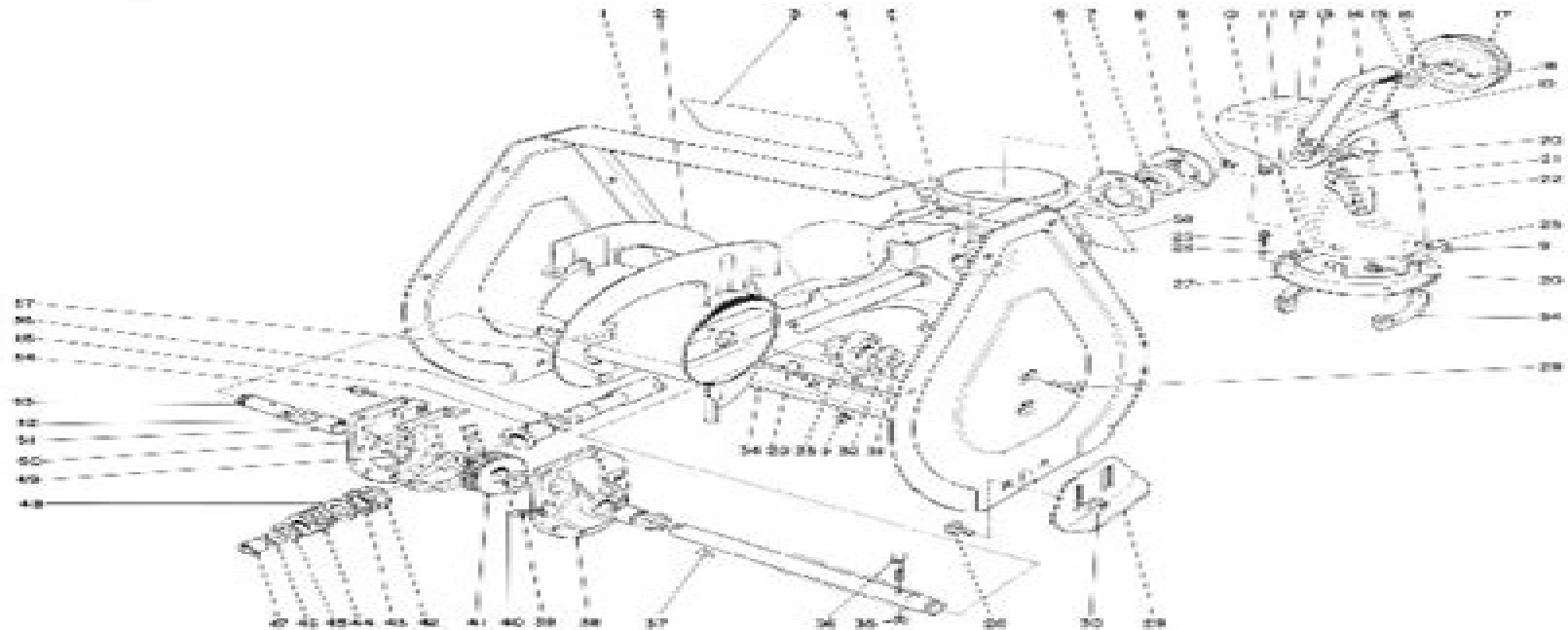

MODEL NO. 38035-7000001 & UP

**PARTS
CATALOG**
3521 SNOWTHROWER

AUGER ASSEMBLY

Ref. No.	Part No.	Description	No. Used
1	42-7320	Auger Housing	1
2	39-1180	Auger R.H.	1
3	39-1190	Auger L.H.	1
4	54-9910	Decol — Auger Warning	1
5	37-6990	Shaft & Impeller	1
6	3230-10	Carriage Bolt	2
7	26-6110	Flange — Bearing (Front)	1
8	26-6100	Ball Bearing	1
9	26-6120	Flange — Bearing (Rear)	1
10	3296-29	Locknut	1
11	3215-2-1	Locknut	2
12	3290-340	Washer Belleville	2
13	20-1320	Washer Rubber	2
14	53-7660	Decol — Discharge	1
15	37-8930	Handle Deflector	1
16	3-0737	Washer	1
18	32b7-5	Key	1

Ref. No.	Part No.	Description	No. Used
17	37-1690	Pulley	1
18	3242-4	Set Screw	2
19	11-3059	Deflector (Inc. Ref. #13)	1
20	3250-1	Carriage Bolt	14
21	53-7690	Wire — Chute	1
22	53-7600	Chute — Discharge	1
23	3256-23	Washer	3
24	37-6490	Retainer — Chute Ring	3
25	27-0230	Self Tapping Screw	6
26	3290-326	Push Nut	1
27	37-0940	Chute Ring	1
28	32144-70	Self Tapping Screw	4
29	40-8160	Skid	2
30	32128-20	Flange Nut	4
31	32151-36	Snap Ring	2
32	5-1560	Thrust Washer	1
33	37-6510	Auger Bearing	1

*Not Illustrated

*The Toro Company — 1986

PRICE \$1.00

Toro 38035 Service Manual

Michal Rosen-Zvi



Toro 38035 Service Manual:

Catalog of Copyright Entries ,1929-07 Maintenance Manual, Toro-flow Diesel Engine General Motors Corporation.
GMC Truck & Coach Division,1964 *Toro-flow Diesel Engine* General Motors Corporation. GMC Truck & Coach
Division,1965 **Maintenance Manual Toro-flow Diesel Engine, GMC Trucks** ,1968

Uncover the mysteries within Crafted by is enigmatic creation, Embark on a Mystery with **Toro 38035 Service Manual** . This downloadable ebook, shrouded in suspense, is available in a PDF format (Download in PDF: *). Dive into a world of uncertainty and anticipation. Download now to unravel the secrets hidden within the pages.

<http://www.frostbox.com/About/virtual-library/fetch.php/Wholemeal%20Bread%20Rolls%20Recipe.pdf>

Table of Contents Toro 38035 Service Manual

1. Understanding the eBook Toro 38035 Service Manual
 - The Rise of Digital Reading Toro 38035 Service Manual
 - Advantages of eBooks Over Traditional Books
2. Identifying Toro 38035 Service Manual
 - Exploring Different Genres
 - Considering Fiction vs. Non-Fiction
 - Determining Your Reading Goals
3. Choosing the Right eBook Platform
 - Popular eBook Platforms
 - Features to Look for in an Toro 38035 Service Manual
 - User-Friendly Interface
4. Exploring eBook Recommendations from Toro 38035 Service Manual
 - Personalized Recommendations
 - Toro 38035 Service Manual User Reviews and Ratings
 - Toro 38035 Service Manual and Bestseller Lists
5. Accessing Toro 38035 Service Manual Free and Paid eBooks
 - Toro 38035 Service Manual Public Domain eBooks
 - Toro 38035 Service Manual eBook Subscription Services
 - Toro 38035 Service Manual Budget-Friendly Options
6. Navigating Toro 38035 Service Manual eBook Formats

- ePub, PDF, MOBI, and More
 - Toro 38035 Service Manual Compatibility with Devices
 - Toro 38035 Service Manual Enhanced eBook Features
7. Enhancing Your Reading Experience
 - Adjustable Fonts and Text Sizes of Toro 38035 Service Manual
 - Highlighting and Note-Taking Toro 38035 Service Manual
 - Interactive Elements Toro 38035 Service Manual
 8. Staying Engaged with Toro 38035 Service Manual
 - Joining Online Reading Communities
 - Participating in Virtual Book Clubs
 - Following Authors and Publishers Toro 38035 Service Manual
 9. Balancing eBooks and Physical Books Toro 38035 Service Manual
 - Benefits of a Digital Library
 - Creating a Diverse Reading Collection Toro 38035 Service Manual
 10. Overcoming Reading Challenges
 - Dealing with Digital Eye Strain
 - Minimizing Distractions
 - Managing Screen Time
 11. Cultivating a Reading Routine Toro 38035 Service Manual
 - Setting Reading Goals Toro 38035 Service Manual
 - Carving Out Dedicated Reading Time
 12. Sourcing Reliable Information of Toro 38035 Service Manual
 - Fact-Checking eBook Content of Toro 38035 Service Manual
 - Distinguishing Credible Sources
 13. Promoting Lifelong Learning
 - Utilizing eBooks for Skill Development
 - Exploring Educational eBooks
 14. Embracing eBook Trends
 - Integration of Multimedia Elements
 - Interactive and Gamified eBooks

Toro 38035 Service Manual Introduction

In today's digital age, the availability of Toro 38035 Service Manual books and manuals for download has revolutionized the way we access information. Gone are the days of physically flipping through pages and carrying heavy textbooks or manuals. With just a few clicks, we can now access a wealth of knowledge from the comfort of our own homes or on the go. This article will explore the advantages of Toro 38035 Service Manual books and manuals for download, along with some popular platforms that offer these resources. One of the significant advantages of Toro 38035 Service Manual books and manuals for download is the cost-saving aspect. Traditional books and manuals can be costly, especially if you need to purchase several of them for educational or professional purposes. By accessing Toro 38035 Service Manual versions, you eliminate the need to spend money on physical copies. This not only saves you money but also reduces the environmental impact associated with book production and transportation. Furthermore, Toro 38035 Service Manual books and manuals for download are incredibly convenient. With just a computer or smartphone and an internet connection, you can access a vast library of resources on any subject imaginable. Whether you're a student looking for textbooks, a professional seeking industry-specific manuals, or someone interested in self-improvement, these digital resources provide an efficient and accessible means of acquiring knowledge. Moreover, PDF books and manuals offer a range of benefits compared to other digital formats. PDF files are designed to retain their formatting regardless of the device used to open them. This ensures that the content appears exactly as intended by the author, with no loss of formatting or missing graphics. Additionally, PDF files can be easily annotated, bookmarked, and searched for specific terms, making them highly practical for studying or referencing. When it comes to accessing Toro 38035 Service Manual books and manuals, several platforms offer an extensive collection of resources. One such platform is Project Gutenberg, a nonprofit organization that provides over 60,000 free eBooks. These books are primarily in the public domain, meaning they can be freely distributed and downloaded. Project Gutenberg offers a wide range of classic literature, making it an excellent resource for literature enthusiasts. Another popular platform for Toro 38035 Service Manual books and manuals is Open Library. Open Library is an initiative of the Internet Archive, a non-profit organization dedicated to digitizing cultural artifacts and making them accessible to the public. Open Library hosts millions of books, including both public domain works and contemporary titles. It also allows users to borrow digital copies of certain books for a limited period, similar to a library lending system. Additionally, many universities and educational institutions have their own digital libraries that provide free access to PDF books and manuals. These libraries often offer academic texts, research papers, and technical manuals, making them invaluable resources for students and researchers. Some notable examples include MIT OpenCourseWare, which offers free access to course materials from the Massachusetts Institute of Technology, and the Digital Public Library of America, which provides a vast collection of digitized books and historical documents. In conclusion, Toro 38035 Service Manual books and manuals for download have transformed the way we access

information. They provide a cost-effective and convenient means of acquiring knowledge, offering the ability to access a vast library of resources at our fingertips. With platforms like Project Gutenberg, Open Library, and various digital libraries offered by educational institutions, we have access to an ever-expanding collection of books and manuals. Whether for educational, professional, or personal purposes, these digital resources serve as valuable tools for continuous learning and self-improvement. So why not take advantage of the vast world of Toro 38035 Service Manual books and manuals for download and embark on your journey of knowledge?

FAQs About Toro 38035 Service Manual Books

How do I know which eBook platform is the best for me? Finding the best eBook platform depends on your reading preferences and device compatibility. Research different platforms, read user reviews, and explore their features before making a choice. Are free eBooks of good quality? Yes, many reputable platforms offer high-quality free eBooks, including classics and public domain works. However, make sure to verify the source to ensure the eBook credibility. Can I read eBooks without an eReader? Absolutely! Most eBook platforms offer webbased readers or mobile apps that allow you to read eBooks on your computer, tablet, or smartphone. How do I avoid digital eye strain while reading eBooks? To prevent digital eye strain, take regular breaks, adjust the font size and background color, and ensure proper lighting while reading eBooks. What the advantage of interactive eBooks? Interactive eBooks incorporate multimedia elements, quizzes, and activities, enhancing the reader engagement and providing a more immersive learning experience. Toro 38035 Service Manual is one of the best book in our library for free trial. We provide copy of Toro 38035 Service Manual in digital format, so the resources that you find are reliable. There are also many Ebooks of related with Toro 38035 Service Manual. Where to download Toro 38035 Service Manual online for free? Are you looking for Toro 38035 Service Manual PDF? This is definitely going to save you time and cash in something you should think about. If you trying to find then search around for online. Without a doubt there are numerous these available and many of them have the freedom. However without doubt you receive whatever you purchase. An alternate way to get ideas is always to check another Toro 38035 Service Manual. This method for see exactly what may be included and adopt these ideas to your book. This site will almost certainly help you save time and effort, money and stress. If you are looking for free books then you really should consider finding to assist you try this. Several of Toro 38035 Service Manual are for sale to free while some are payable. If you arent sure if the books you would like to download works with for usage along with your computer, it is possible to download free trials. The free guides make it easy for someone to free access online library for download books to your device. You can get free download on free trial for lots of books categories. Our library is the biggest of these that have literally hundreds of thousands of different products categories

represented. You will also see that there are specific sites catered to different product types or categories, brands or niches related with Toro 38035 Service Manual. So depending on what exactly you are searching, you will be able to choose e books to suit your own need. Need to access completely for Campbell Biology Seventh Edition book? Access Ebook without any digging. And by having access to our ebook online or by storing it on your computer, you have convenient answers with Toro 38035 Service Manual To get started finding Toro 38035 Service Manual, you are right to find our website which has a comprehensive collection of books online. Our library is the biggest of these that have literally hundreds of thousands of different products represented. You will also see that there are specific sites catered to different categories or niches related with Toro 38035 Service Manual So depending on what exactly you are searching, you will be able to choose ebook to suit your own need. Thank you for reading Toro 38035 Service Manual. Maybe you have knowledge that, people have search numerous times for their favorite readings like this Toro 38035 Service Manual, but end up in harmful downloads. Rather than reading a good book with a cup of coffee in the afternoon, instead they juggled with some harmful bugs inside their laptop. Toro 38035 Service Manual is available in our book collection an online access to it is set as public so you can download it instantly. Our digital library spans in multiple locations, allowing you to get the most less latency time to download any of our books like this one. Merely said, Toro 38035 Service Manual is universally compatible with any devices to read.

Find Toro 38035 Service Manual :

wholemeal bread rolls recipe

~~wild bird seed recipe~~

william deen solution manual

~~wiedzma opiekunka czesc 1 wolha redna 3~~

wild ta10 bl service manual

who is jk rowling

~~wiley financial accounting solutions ch 11~~

wicked ties wicked lovers series book 1

~~why do most americans drive automatic cars~~

why is health important essay

why you are not married yet book

who is bolsa in edgenuity

why college matters to god a students

wiley control systems 6th edition nise solutions
william blake 100 selected drawings

Toro 38035 Service Manual :

eps topik questions practice in nepali korean vasa class 3 - Mar 10 2023

web feb 18 2019 eps [\[link\]](#) korean language in nepali eps topik nepal korean language learn in nepali hrd korea

learn korean bhasa eps topik apps on google play - Jan 08 2023

web jul 21 2023 eligible nepali citizens can fill out the online application form who are interested in the list received from hrd service of korea and want to join the special korean language test special eps topik cbt documents required for application registration to complete the application process the following documents are required
[eps korea language exam application open nepal korea eps](#) - Nov 25 2021

eps section nepal apps on google play - Jan 28 2022

web jul 14 2023 from the hrd service of korea dated february 2079 to select candidates for sending nepali workers to the republic of korea under the employment permit system

eps topik basic korean meaning in nepali language youtube - Apr 30 2022

web mar 15 2022 eps branch nepal has opened the application for the 2022 korean language special exam special eps topik 2022 which has been delayed for a long
[application for korean language test is now open nepalnews](#) - Jun 01 2022

web eps korea section was established under government of nepal ministry of labour and employment department of foreign employment on 26th july 2007 7th shrawan

korean eps topik book apps on google play - May 12 2023

web government of nepal announces special korean language test special eps topik cbt 2023 the foreign employment department ministry of labour employment and

eps topik nepali book topik test korea - Aug 03 2022

web nov 22 2022 the videos herein are based on korean language course eps promoting e learning in nepal and are made with intention to provide guidance to the students

eps center nepal - Jun 13 2023

web may 10 2023 4 32k reviews 100k downloads everyone info install about this app arrow forward hello user this is korean

eps topik book self study textbook you

eps topik meaning book in nepa apps on google - Feb 26 2022

web jan 1 2019 eps topik or employment permit system topik is purposely designed for foreign workers who are planning to seek jobs in korea basic understanding of korean

eps korean language test 2021 2022 updates in - Nov 06 2022

web eps topik make sure the eps topik score eps topik question book download eps topik site epstopik hrdkorea or kr announcement on the temporary suspension of special eps topik 2018

south korea recruiting 40 000 nepali workers through - Feb 09 2023

web may 17 2021 eps korean language test 2021 2022 updates in nepal as pandemic grips country korean language test uncertain this year as well with the country reeling

eps topik nepali book apps on google play - Aug 15 2023

web apr 5 2022 korean language learning app designed specifically for nepali eps students our app is the perfect tool to help you learn korean quickly and easily with

employment permit system - Jul 02 2022

web jul 27 2023 eps korea section serves thousands of nepalese people department of foreign employment eps in co operation with south korean government has created

eps korea result check eps topik nepal result name lists - Aug 23 2021

learn korean eps nepal 2023 apps on google play - Jul 14 2023

web important links eps korea shakha embassy of nepal south korea embassy of the republic of korea nepal south korea immigration eps id pbt cbt result pbt

eps - Dec 07 2022

web eps topik book in nepali languages chapter 01 I master hangeul the korean alphabet I

special eps topik cbt 2023 application exam result - Apr 11 2023

web mar 8 2023 eps topik questions practice in nepali korean vasa class 3 topik questions solution youtube eps korean listening exam episodeseeps korean listening exam all episodeseeps korea

korean language course basic and advanced grammar - Mar 30 2022

web information about employment view immigration progress view immigration progress more legal position of foreign workers more eps test of proficiency in korean more







employment permit system - Oct 25 2021

learn korean bhasa in nepali apps on google play - Oct 05 2022

web mar 14 2022 applications for the korean language test are open under the employment permit system eps the eps korea branch today issued a notice requesting

eps section nepal on the app store - Dec 27 2021

application for eps topik 2023 government of nepal - Sep 04 2022

web may 24 2019 eps topik basic korean meaning in nepali language    listening dawonload    how to eps topic

download eps topik text book blogger - Sep 23 2021

be good be real be crazy read online free without - Jun 22 2022

web in the tradition of let s get lost and amy roger s epic detour be good be real be crazy is a story about love friendship and finding yourself this is a novel to be savored

be good be real be crazy kindle edition amazon com - Aug 05 2023

web 4 quotes from be good be real be crazy if you believe in gravity you already believe in something higher than yourself

be good be real be crazy philpot chelsey amazon sg books - Mar 20 2022

web praise for even in paradise if you re a certain kind of reader there s a very good chance you have both gossip girl and the great gatsby on your bookshelf even in

be good be real be crazy hardcover barnes noble - Sep 25 2022

web oct 11 2016 three teenagers one road trip countless detours from the author of even in paradise comes a story about love friendship and finding yourself that is perfect for

be good be real be crazy on apple books - Nov 15 2021

web nov 5 2023 the concept was good but we have unbelievable technology it can shoot a needle out of the air it is incredible it is just crazy it is crazy to see it it is crazy to

be good be real be crazy harpercollins - Aug 25 2022

web three teenagers one road trip countless detours from the author of even in paradise comes a story about love friendship and finding yourself that is perfect for fans of paper

be good be real be crazy 9780062293725 9780062293749 - Oct 27 2022

web oct 11 2016 home1 books2 be good be real be crazy 272 by chelsey philpotchelsey philpot editorial reviews read an excerpt of this book add to wishlist be good be

be good be real be crazy philpot chelsey amazon in books - Jan 30 2023

web buy be good be real be crazy by philpot chelsey online on amazon ae at best prices fast and free shipping free returns cash on delivery available on eligible purchase

be good be real be crazy chelsey philpot - May 22 2022

web three teenagers one road trip countless detours from the author of even in paradise comes a story about love friendship and finding yourself that is perfect for fans of paper

be good be real be crazy by philpot chelsey amazon ae - Dec 29 2022

web language english 265 pages 22 cm homer mia and einstein are three aimless teenagers searching for meaning on an epic road trip up the east coast a journey that

sport ballon d or 2023 qui sera le vainqueur laura - Sep 13 2021

be good be real be crazy by chelsey philpot goodreads - Oct 07 2023

web oct 11 2016 151 ratings45 reviews three teenagers one road trip countless detours from the author of even in paradise comes a compelling story of self discovery that is

be good be real be crazy by chelsey philpot ebook - Jul 24 2022

web be good be real be crazy read free ebook by chelsey philpot in online reader directly on the web page select files or add your book in reader

be good be real be crazy philpot chelsey author free - Nov 27 2022

web be good be real be crazy is written by chelsey philpot and published by harperteen the digital and etextbook isbn for be good be real be crazy are 9780062293749

be good be real be crazy overdrive - Jan 18 2022

web three teenagers one road trip countless detours from the author of even in paradise comes a story about love friendship and finding yourself that is per

be good be real be crazy amazon com - Sep 06 2023

web oct 11 2016 in be good be real be crazy we follow homer and einstein a pair of adoptive teenage brothers as they shepherd the entrancing mia from their home in the

be good be real be crazy by chelsey philpot kirkus - May 02 2023

web read be good be real be crazy by chelsey philpot with a free trial read millions of ebooks and audiobooks on the web ipad iphone and android

be good be real be crazy by chelsey philpot publishers weekly - Feb 28 2023

web select the department you want to search in

trump millions of people would be alive now if - Oct 15 2021

web laura dave media vous permet de suivre en ce moment la cérémonie du ballon d or officiel soyez les témoins de ce duel privilégié entre messi et halland

be good be real be crazy by chelsey philpot ebook scribd - Apr 01 2023

web be good be real be crazy chelsey philpot harperteen 17 99 272p isbn 978 0 06 229372 5

be good be real be crazy by chelsey philpot google play - Jun 03 2023

web be good be real be crazy by chelsey philpot age range 14 16 buy now from amazon barnes noble local bookseller get weekly book

be good be real be crazy by chelsey philpot epic reads - Apr 20 2022

web hello sign in account lists returns orders cart

be good be real be crazy hardcover golden lab bookshop - Feb 16 2022

web oct 11 2016 be good be real be crazy ebook by chelsey philpot read a sample format ebook isbn 9780062293725 author chelsey philpot publisher harpercollins

be good be real be crazy quotes by chelsey philpot goodreads - Jul 04 2023

web be good be real be crazy ebook written by chelsey philpot read this book using google play books app on your pc android ios devices download for offline reading

be good be real be crazy chelsey philpot ebook - Dec 17 2021

web oct 11 2016 be good be real be crazy chelsey philpot 7 99 7 99 publisher description three teenagers one road trip countless detours from the author of even

heat and mass transfer by r k rajput pbk 2008 reprint - Mar 29 2022

web heat and mass transfer by rk rajput click the start the download download pdf report this file description heat and mass transfer textbook account 157 55 39 239

heat and mass transfer si unit book pdf by - Nov 05 2022

web oct 28 1998 205 ratings5 reviews hear and mass transfer is a comprehensive textbook for the students of mechanical engineering and a must buy for the aspirants of different

rajput r k heat and mass transfer a textbook pdf pdf - Apr 10 2023

web fegie heat and mass transfer a net heat accumulated in the element due to conduction of heat from all the coordinate directions considered heat flow through r 8 plane

a textbook of heat and mass transfer concise edition rk - Jan 07 2023

web a textbook of heat and mass transfer concise edition author rk rajput publisher s chand publishing isbn 9385401939 9789385401930 export citation bibtex

heat and mass transfer r k rajput google books - May 11 2023

web r k rajput s chand 2007 gate exams 864 pages the entire book has been thoroughly revised and a large number of solved examples under heading additional typical

heat and mass transfer r k rajput studocu - Nov 24 2021

web a textbook of heat and mass transfer ebook written by rk rajput read this book using google play books app on your pc android ios devices download for offline reading

pdf heat and mass transfer r k rajput free download pdf - Aug 14 2023

web description download heat and mass transfer r k rajput free in pdf format

heat mass transfer book by r k rajput faadooengineers - Oct 24 2021

a textbook of heat and mass transfer r k rajput - Jul 01 2022

web aug 24 2019 author of textbook of heat and mass transfer strength of materials a textbook of engineering thermodynamics dec 01 2007 rajput r k thermal

referenceglobe - May 31 2022

web jan 30 2009 the book commences with a chapter on the basic concepts of heat and mass transfer including topics like thermodynamics modes of heat transfer and its

a textbook of heat and mass transfer 7e rajput r k google - Feb 08 2023

web a textbook of heat and mass transfer 7e rajput r k s chand publishing 2019 technology engineering heat and mass transfer is a comprehensive textbook for

download heat mass transfer by r k rajput documents and - Mar 09 2023

web download heat mass transfer by r k rajput type pdf date november 2019 size 33 6mb author raunak kishore this document was uploaded by user and they

pdf heat transfer handbook book pdf by r k rajput scribd - Dec 26 2021

web sep 3 2014 results 1 to 1 of 1 thread heat mass transfer book by r k rajput popular topic for study zigbee and ieee 802 15 4 the section explains the zigbee and ieee

heat and mass transfer english paperback rk rajput - Feb 25 2022

web files type pdf heat and mass transfer by frank kreith engineering thermodynamics by r k rajput applied thermodynamics by onkar singh temperature of hot water by

a textbook of heat and mass transfer concise edition by rk - Dec 06 2022

web a textbook of heat and mass transfer concise edition ebook written by rk rajput read this book using google play books app on your pc android ios devices

r k rajput open library - Apr 29 2022

web amazon in buy heat and mass transfer english paperback rk rajput book online at best prices in india on amazon in read heat and mass transfer english paperback

pdf heat and mass transfer by rk rajput free download pdf - Jan 27 2022

web r k rajput book heat and mass transfer follow this book documents 4 students 23 summaries date rating year ratings stainless steel 5 pages 2018 2019 none

a textbook of heat and mass transfer rk rajput google books - Jul 13 2023

web a textbook of heat and mass transfer rk rajput s chand publishing heat and mass transfer is a comprehensive textbook for the students of mechanical engineering and a

[a textbook of heat and mass transfer kindle edition amazon in](#) - Sep 03 2022

web a textbook of heat and mass transfer paperback 1 january 2015 a textbook of heat and mass transfer paperback 1 january 2015 by r k

heat and mass transfer by r k rajput goodreads - Oct 04 2022

web divided into 5 parts the book delves into the subject beginning from basic concepts and goes on to discuss heat transfer by convection and radiation and mass transfer

a textbook of heat and mass transfer by rk rajput google play - Sep 22 2021

[heat mass transfer by r k rajput documents and e books](#) - Jun 12 2023

web download view heat mass transfer by r k rajput as pdf for free more details pages 919 preview full text download view heat mass transfer by r k rajput

[heat and mass transfer r k rajput](#) - Aug 02 2022

web referenceglobe